

MANISCOPIC

MLT 523

TURBO

Evolution

- Maximum lifting height : 4.97 m
- Capacity : 2300 kg
- Maximum forward reach : 2.82 m
- Hydrostatic transmission
- JSM : an «all in one» system

1) *Hydraulic controls*

2) *Forward/Reverse selection*

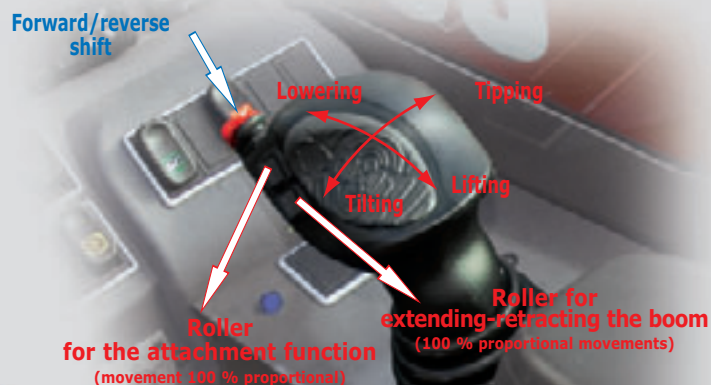

MLT 523 T with a CBA 1500



MANITOU

MLT 523 T

 **Lifting capacity**2300 kg
at 500 mm from forks heels
Tipping load at maximum reach :1535 kg
Tear out force with bucket
to ISO 8313.....4050 daN

 **Lifting height**4.97 m
Times : unladen / loaded (in s)
Lifting.....6.27/6.5
Lowering.....4.64/4.54
Boom
extension4.62/4.83
retraction3.55/3.84
Time unladen (in s)
Crowd3.02
Dump.....2.51

 **Tyres**
12.5 - 80 - 18 SGI
Option 10.5 - 18 TG 42 10 PR

 **Forks (mm)**
Length.....1200
Width.....125

 **Oil bath multidisc brakes on front axle**

 **Engine KUBOTA STAGE III A**
Type.....V3307 DI-T
Cylinder.....4/3331 cm³
Power (ISO 3046-1)
Turbo75 HP/55 Kw
Maximum torque265 Nm at 1500 tr/mn
Direct injection
Water cooling

 **Transmission**hydrostatic
Electro - hydraulic reversing shift
One speed forward and reverse
Maximum travel speed up to.....25 km/h*

 **Hydraulics**
Lifting/tilting pump : gear type :...89 l./mn à 260 bars
Flow divider with priority to steering

 **Capacities**
Cooling system.....13.7 l.
Transmission oil.....123 l.
Engine oil.....11.2 l.
Fuel tank.....94 l.

 **Weight unladen (with forks)**5240 kg
Overall width1.80 m
Overall height.....1.98** or 2.01 m
Turning radius (outside wheels)3.02 m
Overall length4.20 m
Ground clearance0.30 m
Drawbar pull.....3495 daN

** Tyres : 10.5 - 18

This publication in no way constitutes an offer and the company reserves the right to alter specification without prior notice.
Model illustrated may have optional equipment which is available at additional cost.
Operator shall conform with applicable regulation.
* Can change according to the local regulation.



MANITOU BF SA
B.P. 249 - 44158 Ancenis Cedex - France
Tel. : 33 2 40 09 10 11 / Export Department Fax : 33 2 40 09 10 97
www.manitou.com

700042EN-C - 02/09 - BE 515 Ind A

Reach at maximum height : 0,64 m

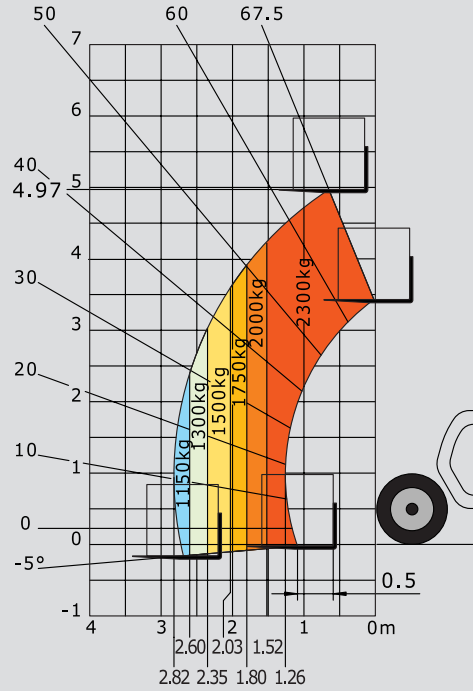

Under EN 1459 annexe B

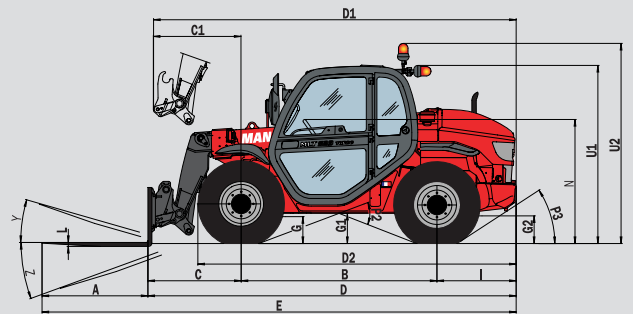

	MLT 523 Turbo
A	1200
B	2230
C	1069.5
C1	1005
D	4204.5
D1	4140
D2	3626
E	5404.5
F	1500
F1	1500
G	305
G1	355
G2	325
I	905
J	865
K	1020
L	45
N	1410
O	125
P2	39°
P3	31°
R	2870
S	6409
T	3130
U1	2010
U2	2300
V	4125
V1	995
V2	3025
W	1809
Y	12°
Z	120°

(mm)

